





<p><b>JET 6 2.8kW</b> 1000851US <b>JET 6 5.6kW</b> 1000850US</p> 	<p><b>JET TWIN</b> 1000855US</p> 	<p><b>DIMENSIONS</b></p> 
<ul style="list-style-type: none"> <li>&gt; Single (1.5 gallon) or Twin (3 gallon) options</li> <li>&gt; Pre-set recipe and volume options</li> <li>&gt; Variable batch volumes</li> <li>&gt; Basket safety lock during brewing</li> </ul>	<ul style="list-style-type: none"> <li>&gt; Operator friendly and easy-to-use</li> <li>&gt; Vacuum insulated urn for energy-efficiency and temperature retention</li> <li>&gt; Two power options</li> </ul>	

ASSOCIATED PRODUCTS (SOLD SEPARATELY)

REQUIRED	OPTIONAL
<p><b>JET URN</b> 1700204</p> 	<p><b>JET GRINDER</b> 1000891</p> 

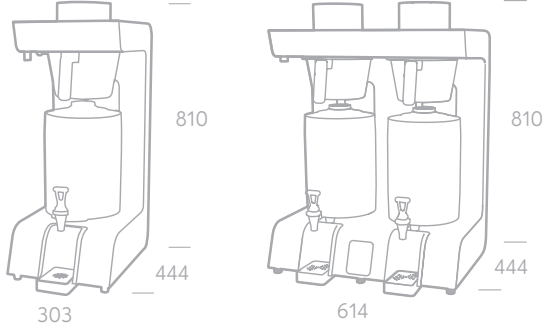
PRECISE, PROGRAMMABLE BATCH BREWER FOR HIGHER VOLUME REQUIREMENTS.

BREWERS

PRODUCT INFO	PERFORMANCE SPECS	SIZE	PLUMBING & ELECTRICAL REQS			PACKAGING		
			POWER @ 230V	PLUMBING REQS	NEMA	PACKED WEIGHT	PACKAGING DIMENSIONS (L x W x H inches)	QTY / PALLET
Jet 6 2.8kW 1000851US	1.5 GAL	16.9 x 11.9 x 33	2.8kW	3/8" Compression or 3/8" John Guest	L6-20P	52.9lb	19.6 x 15.7 x 35.4	6
Jet 6 5.6kW 1000850US			5.6kW		L6-30P			
Jet Twin 1000855US	1.5 GAL (per urn)	18.2 x 24.2 x 35.3				106lb	19.6 x 27.9 x 36.2	2

ACCESSORIES

PRODUCT INFO	SIZE	PACKAGING		
NAME ORDER CODE	DIMENSIONS (D x W x H inches)	PACKED WEIGHT	PACKAGING DIMENSIONS (L x W x H inches)	QTY / PALLET
Jet Urn 1700204	16.5 x 9.6 x 22.4	15.4lbs	25.1 x 12.2 x 17.3	16
Jet Grinder 1000891	14.5 x 7.4 x 22	55lbs	22.8 x 11.8 x 31.4	12

## JET 6 BATCH BREWER

JET 6 2.8KW 1000851US

JET 6 5.6KW 1000850US

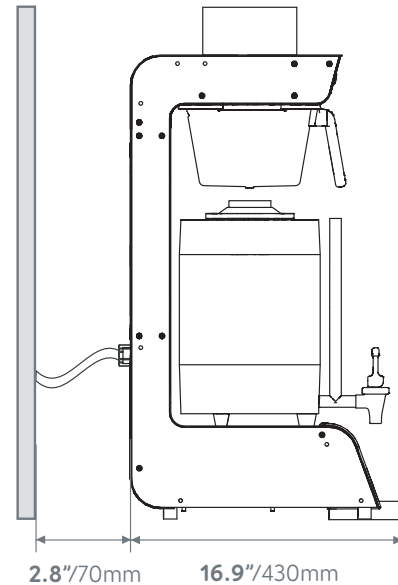
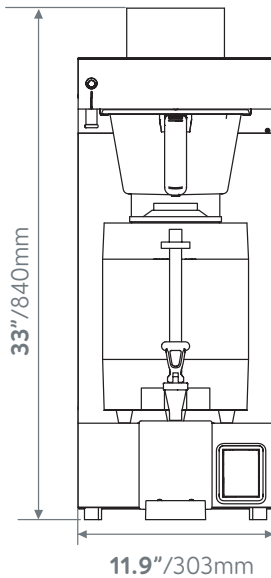
**VENTILATION REQUIREMENTS**

- Back: 70mm/2.7"
- Sides: 50mm/1.9"

Clearance required around machine if installed in an enclosed cabinet.

**ELECTRICAL INSTALLATION PROCEDURE**

1000850US - 5.6kW/200-230V ac

When installing the machine, always observe the local regulations and standards. The appliance is supplied with a NEMA L6-30P power cord. A suitable mains power supply socket should be available within easy access of the appliance so that it can be disconnected easily after install.

1000851US - 2.8kW/200-230V ac

When installing the machine, always observe the local regulations and standards. The appliance is supplied with a NEMA L6-20P power cord. A suitable mains power supply socket should be available within easy access of the appliance so that it can be disconnected easily after install.

**PLUMBING INSTALLATION PROCEDURE**

- Ensure that the equipment is installed according to local plumbing & water regulations.
- Mains water pressure required (limits): 8 -145psi (55 -1000kPa, 0.05 - 1MPa).
- Requires inline water filter within your water specifications.
- The machine requires either a 3/8" compression, or 3/8" John Guest water connection.
- Turn on the water to flush any impurities, dust etc from the inlet hose and water pipe. Allow several litres through. Especially for new installations.
- Connect the hose to the inlet valve of the boiler. Make sure a sealing washer is fitted.
- Turn on water and check for leaks.
- The SP9 Head has a drip tray attached with a drain outlet which should be plumbed to waste.